

FE779 Eye/Face Wash, Deck Mounted AutoFlow™ 90° Swing-Down

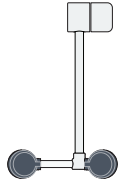

FE779LH-L

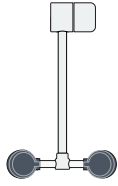

FE779LH

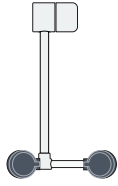

FE779LH-R

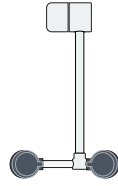

FE779L

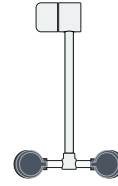

FE779

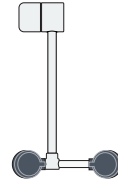

FE779R



Application: AutoFlow™ eye/face wash for mounting on counter. Spray heads swing down from storage to operational position, activating water flow. Available in a variety of spray head configurations to minimize obstructions at a sink. *Note: If unit is not installed at a sink, floor drain should be provided underneath unit to prevent accumulation of water on floor.*

Spray Head Assembly: Two FS-Plus™ spray heads. Each head has a “flip top” dust cover, internal flow control and filter to remove impurities from the water flow.

Valve: 1/2" IPS plug-type valve with PTFE coated O-ring seals. Swinging head assembly down from storage to operational position opens orifice and activates water flow. Unit remains in operation until spray head assembly is returned to storage position.

Strainer: Unit is furnished with in-line strainer to protect valve and spray heads from debris in water line.

Mounting: Valve is installed in chrome plated brass housing. Unit mounts on countertop behind sink. Furnished with mounting hardware for securing unit to counter.

Construction: Polished chrome plated brass.

Supply: 1/2" NPT female inlet.

Sign: ANSI-compliant identification sign.

Quality Assurance: Unit is completely assembled and water tested prior to shipment.

Available Options

- TM6020** Thermostatic mixing valve precisely blends hot and cold water to deliver tepid water as required by ANSI Z358.1-2014. Refer to “Thermostatic Mixing Valves” section for complete technical and product selection information.

FE779 Eye/Face Wash, Deck Mounted AutoFlow™ 90° Swing-Down

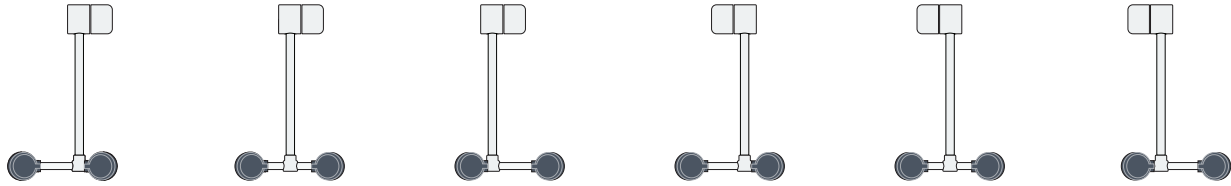

FE779LH-L
FE779LH
FE779LH-R
FE779L
FE779
FE779R

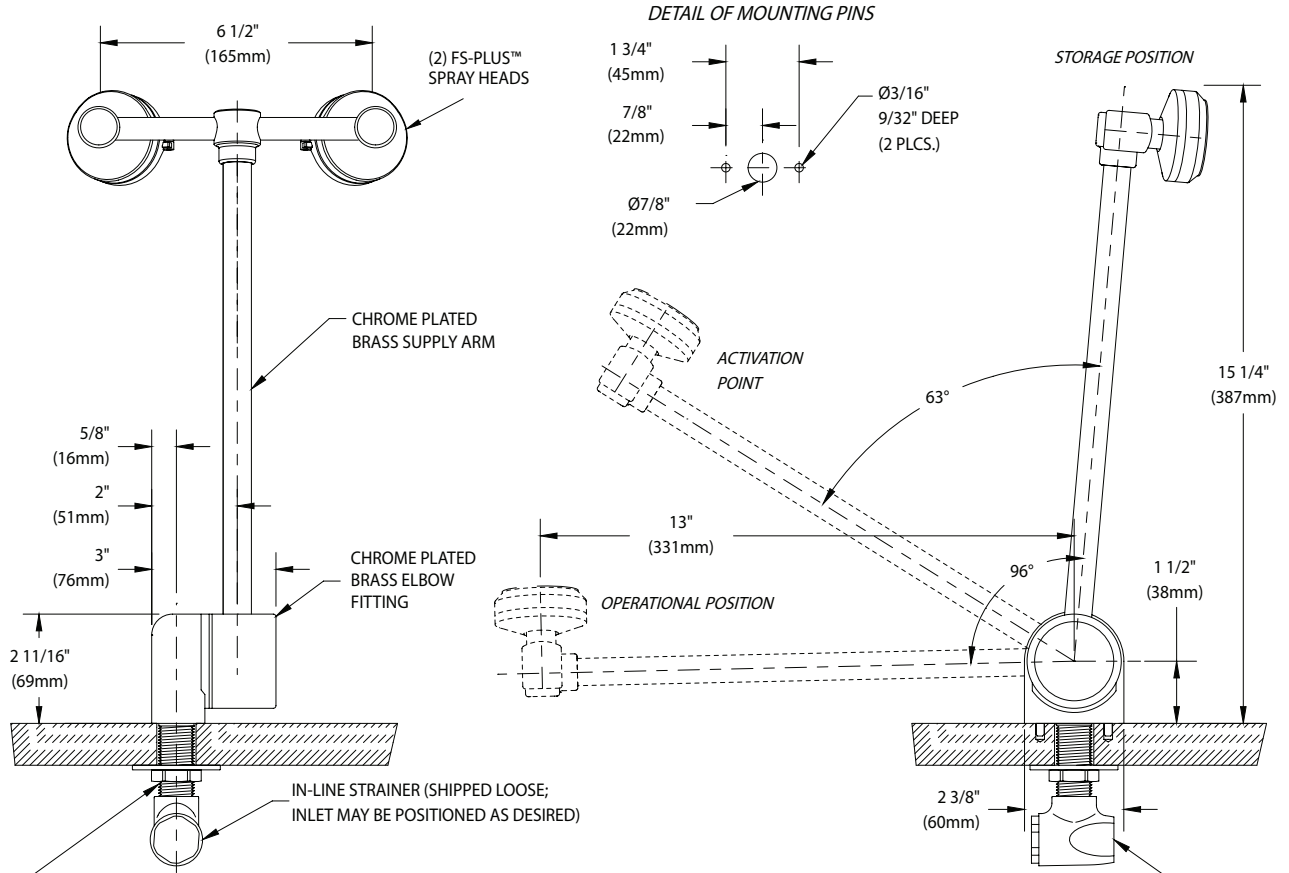

- NOTES:**
1. SWINGING OUTLET HEAD ASSEMBLY DOWN 96 DEGREES FROM VERTICAL TO HORIZONTAL POSITION ACTIVATES WATER FLOW.
 2. EACH FS-PLUS™ SPRAY HEAD HAS A "FLIP-TOP" DUST COVER, INTERNAL FLOW CONTROL AND FILTER TO REMOVE IMPURITIES FROM THE WATER FLOW.
 3. UNIT MOUNTS INTO COUNTERTOPS UP TO 1 1/2" THICK. BASE OF UNIT HAS PINS TO PREVENT UNIT FROM TURNING ON COUNTER.
 4. UNIT IS FURNISHED WITH IN-LINE STRAINER TO PROTECT SPRAY HEADS AND VALVE COMPONENTS FROM DEBRIS IN WATER LINE.
 5. VALVE BEGINS TO OPEN AT "ACTIVATION POINT" SHOWN ABOVE.

THIS SPACE FOR ARCHITECT/ENGINEER APPROVAL

Sign Included



Due to continuing product improvement, the information contained in this document is subject to change without notice. All dimensions are ± 1/4" (6mm). rev. 0422