



INNOVATIVE PRODUCTS FOR RESEARCH

# Installation, Operation and Maintenance Guide:

## Eyewash/Drench Hose Units Drench Hose Units



WaterSaver Faucet Co. is the world's leading manufacturer of emergency eyewash and shower technology for use in laboratory and educational facilities. As such, WaterSaver drench hose units and dual purpose eyewash/drench hose units have been installed in thousands of facilities over the past thirty years. These units are relied upon to instantly flush the user's eyes, face or body should a chemical spill occur.

Like all WaterSaver products, our eyewash/drench hose and drench hose units are designed, engineered and manufactured for reliable performance and exceptional durability. However, like all of our products, they must be installed correctly, operated properly, inspected regularly and maintained periodically to assure that they will be available when needed. This Installation, Operation and Maintenance Guide will assist users and facility maintenance personnel in these activities.

## Application Information

Drench hose units are typically installed on a countertop or a wall and are used to rinse any part of a user's eyes, face or body. These units are equipped with a single FS-Plus™ spray-type outlet head. As a single head unit, they cannot be used as a fixed eyewash unit, since they cannot wash both eyes simultaneously. Under "American National Standard for Emergency Eyewash and Shower Equipment" (ANSI Z358.1-2014), drench hose units support emergency eyewash and shower stations, but do not replace them. Consequently, drench hose units are intended solely as supplemental units providing additional protection, as they cannot serve as the primary means for eyewash protection.

Twenty years ago, WaterSaver introduced the first dual purpose eyewash/drench hose unit. These units are designed to meet the provisions of ANSI Z358.1-2014 as both an eyewash and a drench hose. Dual purpose eyewash/drench hose units are typically installed on a countertop next to or behind a sink. They may also be mounted on a wall. The deck flange or wall bracket positions the unit so the handle and spray heads face forward at all times. In an emergency, the user can use the unit as a fixed eyewash by squeezing the lever handle to activate the water flow. A locking clip on the lever handle holds the valve open, so the user's hands are free during use. The user can lean over the unit to rinse his or her eyes. Alternatively, the user can use the unit as a drench hose by removing it from the deck flange or wall bracket and rinsing any part of his or her eyes, face or body.

## Installation

Installing WaterSaver eyewash/drench hose and drench hose units requires the use of common plumbing installation techniques. Observing the following guidelines will help to assure trouble-free installation:

1. The water supply line should be at least 1/2" OD and should be copper or other corrosion resistant material.
2. Deck mounted units require a 1-3/8" diameter mounting hole. The hole should be large enough to accommodate the shank on the deck flange but not permit excessive lateral movement. Minimizing the hole size provides as large a surface as possible for the locknut and lockwasher to secure against.
3. Thoroughly clean and flush the supply line prior to installing unit. Pipe shavings, scale, tape and other debris can be carried through a pipe and into the unit when the system is activated. This debris can damage valve components and interfere with proper operation of the valve.
4. Units have a 3/8" NPT male thread on the inlet. Use PTFE tape or other pipe sealant to seal this thread. Do not apply the sealant in a way that will permit it to enter into the unit.
5. Units are fully assembled and factory tested prior to shipment. Units are tagged when factory testing is complete. If a unit is received without an inspection tag, please notify the factory.
6. Clean eyewash/drench hose and drench hose units using only a soft cloth and soapy water. Do not use abrasives, detergents or other cleaners that can damage the finish on the unit. *Never use any cleaning agent that contains ammonia near a laboratory service fitting or emergency eyewash unit, as ammonia will aggressively corrode the brass contained in these products.*

In addition to observing these common plumbing installation techniques, there are several additional guidelines specific to these units that must be observed:

1. Install units with adequate clear space around them to be free of obstructions. In an emergency, units should be readily accessible to the user without interference from other equipment (such as mixing faucets, pegboards, instrumentation, etc.). Units should be installed at least 6" from the wall.
2. Install units so that the handle and spray heads face forward toward the user. On deck mounted units, this requires installing the deck flange with the handle locator guides properly positioned.
3. On deck mounted units, make sure that the hose does not bind underneath the counter. In addition, there should be no sharp edges, corners or objects that can rub against the hose. The unit must be able to be removed from the deck flange without restriction or binding and the hose must pull out easily from the deck flange. On deck mounted eyewash/drench hose units, make sure that the unit is accessible from the front edge of the counter on which it is installed.

## Operation

The proper use of an eyewash/drench hose or drench hose unit requires observing a few simple guidelines:

1. All users must be instructed as to the location of all safety equipment in the facility, including emergency eyewash and shower equipment.
2. In the event of a chemical splash or spill, the affected area of the victim's body must be flushed immediately for at least fifteen minutes. For chemical spills to the eyes, the user should hold his or her eyes open as wide as possible to permit the water to reach all areas around the eye.
3. Rinsing the affected area for fifteen minutes is only the first step in treating exposure to a hazardous chemical. Following rinsing, the victim should be examined and treated by a doctor or other trained medical specialist as soon as possible.

## Inspection and Maintenance

Like all emergency eyewash and shower equipment, eyewash/drench hose and drench hose units must be inspected on a regular basis to assure that, in an emergency, they are available for immediate and effective use. WaterSaver recommends that the following inspection schedule be followed for all emergency eyewash and shower equipment:

**Weekly Activation:** In accordance with the provisions of ANSI Z358.1-2014, all emergency equipment should be activated at least weekly to assure proper operation.

**Monthly Maintenance Inspection:** All emergency equipment, including eyewash/drench hose and drench hose units, should be inspected at least monthly to find and address any maintenance issues. The monthly inspection should incorporate the recommended weekly activation of the unit, as well as a thorough inspection of the unit to assure that it is in good operating condition and showing no signs of wear. Particular attention should be paid to the spray heads, valve and hose assembly.

**Annual Compliance Inspection:** All emergency equipment should be inspected at least annually to verify continued compliance with the provisions of ANSI Z358.1-2014.

Each of these inspections is described in more detail below.

### 1. Weekly Activation

Weekly activation is a simple but effective check to make sure that the emergency equipment is in good operating condition. A record of the weekly activation should be maintained on a tag affixed to the unit.

### 2. Monthly Maintenance Inspection

The monthly maintenance inspection of eyewash/drench hose and drench hose units is a longer and more comprehensive inspection than the weekly activation. Listed below are the major elements that this inspection should cover. In addition, WaterSaver has developed the "Monthly Inspection Troubleshooting Guide" included below to assist in the recommended monthly inspections of eyewash/drench hose and drench hose units.

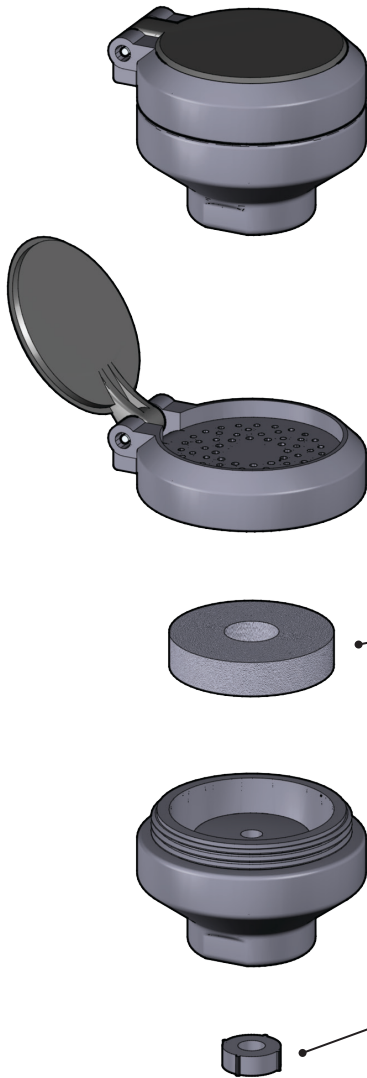

## Spray Heads

**1. Inspect “Flip Top” Dust Cover(s).** WaterSaver developed the “flip top” style dust cover as an alternative to the loose caps with chains that other manufacturers use. The “flip top” cover is attached to the spray head by a permanent stainless steel rivet so it can never be lost or removed. ***Verify that the cover swings freely and is removed from the spray head by the water flow.***

**2. Inspect Filter(s).** Each spray head contains an internal foam filter to remove particles, scale and other debris from the water flow before it enters the user’s eyes. Over time, this foreign matter will collect in the filter. Depending on the amount of foreign matter in the water flow, the filter can become clogged and the flow of water through the spray head can be impaired. ***Inspect filter for debris and/or deterioration. Clean or replace the filter as required.***

**3. Inspect Flow Control(s).** Each spray head contains a flow control to regulate the flow of water through the spray head. The flow control assures that the unit delivers a soft, generous flood of water regardless of incoming water line pressure. Over time, debris can collect in the flow control or it can deteriorate due to age. If this occurs, the flow control must be cleaned or replaced. ***Inspect flow control for debris and/or deterioration. Clean or replace as required.***

## Valve

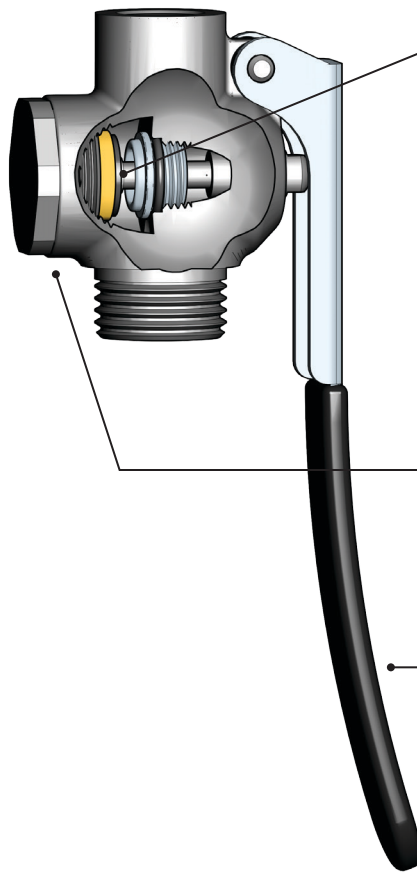

- 1. Inspect Valve for Leakage Through Seat.** The WaterSaver squeeze valve is manufactured from components that will provide the valve with exceptional durability. The valve seat is machined from solid stainless steel bar stock and the valve disc is high durometer synthetic rubber for positive shutoff and exceptional wear resistance. However, it is possible that, over time, these components can wear or be damaged by impurities in the water flow. Therefore, WaterSaver has designed these valves so that all of the wearing components of the valve are removable and replaceable. Should any of the components wear over time and the valve begin to leak, the components can be replaced and the valve will be essentially “as good as new.” ***Inspect valve components for wear and replace as required.***
- 2. Inspect Valve for Leakage Around Valve Stem and Bonnet.** The valve stem and bonnet have O-ring seals to prevent leakage outside of the valve body. These O-rings can over time wear or deteriorate. ***Inspect the unit for signs of leakage around the valve stem and bonnet. Replace the O-rings as required.***
- 3. Inspect Squeeze Handle.** The squeeze handle on the valve is heavy duty stainless steel to withstand bending and resist corrosion. ***Inspect the handle for proper operation.***

## Hose Assembly

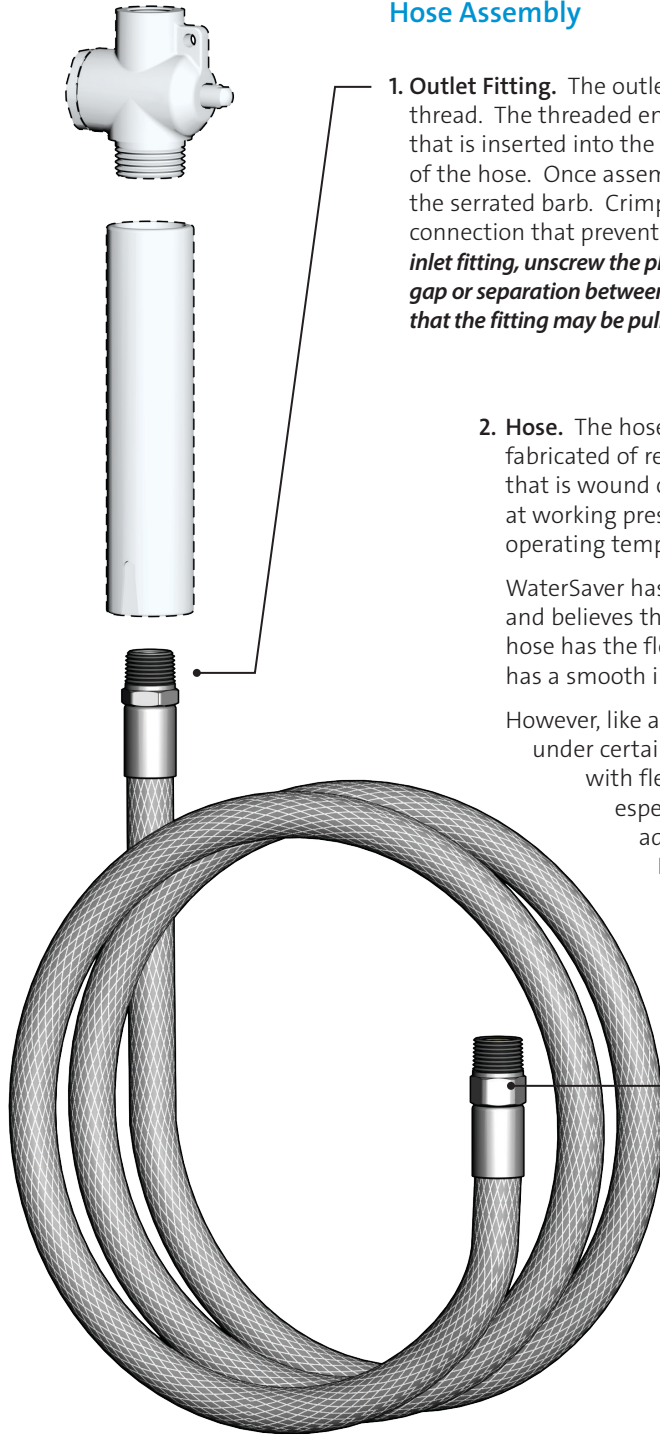

**1. Outlet Fitting.** The outlet of the hose assembly has a brass fitting with a 3/8" NPT male thread. The threaded end connects to the inlet of the valve. The fitting has a serrated barb that is inserted into the inside of the hose. A brass ferrule or sleeve is fitted over the outside of the hose. Once assembled, the ferrule is crimped (crushed) to squeeze the hose onto the serrated barb. Crimping the ferrule over the hose and barb forms a secure, permanent connection that prevents the serrated barb from ever pulling out of the hose. **To inspect the inlet fitting, unscrew the plastic handle of the unit. Check for any sign of leakage. Check also for any gap or separation between the ferrule and the barb fitting. If any leakage or gap is found, it is possible that the fitting may be pulling out of the hose. If this occurs, the hose must be replaced immediately.**

**2. Hose.** The hose on WaterSaver eyewash/drench hose and drench hose units is fabricated of reinforced PVC. The hose has a PVC inner core, a braided polyester yarn that is wound over the inner core, and a PVC outer cover. The hose is rated for use at working pressures up to 275 PSI, has a burst pressure of 1000 PSI and a maximum operating temperature of 150°F.

WaterSaver has used reinforced PVC hose for drench hose units for over thirty years and believes that this hose is the best choice for this application. Reinforced PVC hose has the flexibility of rubber but is much more durable. In addition, the hose has a smooth interior wall surface and is FDA approved for use with potable water.

However, like all elastomeric materials, reinforced PVC is subject to deterioration under certain conditions. PVC contains plasticizers to provide the material with flexibility. Over time, these plasticizers can leach out of the material, especially when exposed to concentrated acids, alkalis or UV light. In addition, exposure to gasoline and oils can cause PVC to harden.

Finally, PVC hose can weaken due to continuous rubbing, abrasion, cuts or tears. Since the hose is under continuous water pressure, the consequence of a rupture can be serious. **Inspect the hose for abrasion, loss of flexibility or other deterioration. If any such deterioration is found, the hose must be replaced immediately.**

**3. Inlet Fitting.** The inlet of the hose assembly has a similar serrated barb fitting, except that the inlet fitting is designed to swivel to facilitate connection of the unit to the water supply. The fitting has a 3/8" NPT male thread for connection to the water supply. The fitting also has a serrated barb that is inserted into the inside of the hose and then secured with a crimped ferrule so as to be non-removable. **Check for any sign of leakage or any gap or separation between the ferrule and the barb fitting. If any leakage or gap is found, it is possible that the fitting may be pulling out of the hose. If this occurs, the hose must be replaced immediately.**

## Monthly Maintenance Troubleshooting Guide

Problem	Potential Cause	Corrective Action
Limited or no water flow from spray heads.	Obstruction in spray heads or water way.	1. Remove spray cover and check for lime or calcium buildup. Clean or replace as necessary.
		2. Inspect filter. Clean or replace as necessary.
		3. Unscrew spray head and check flow control for debris or other obstruction. Clean or replace as necessary.
		4. If these actions do not correct problem, open valve by unscrewing bonnet. Inspect valve for obstruction in waterways. Clean as required.
		5. If unit is equipped with a backflow preventer or vacuum breaker, disassemble device and inspect for debris or other obstructions. Clean as required.
Hinged “flip top” dust cover not opening when unit is activated.	Hinged cover is binding.	1. Make sure hinge between dust cover and spray cover is located at bottom of eyewash spray head.
		2. Make sure hinged cover swings freely from spray head. Replace cover if required.
Water leaking from spray heads when unit is not in use.	Valve is not shutting off completely when handle is in closed position.	Shut off water to unit. Open valve by unscrewing valve bonnet. Inspect valve disc and seat for wear. Replace as required.
Water leaking from around valve stem or bonnet.	Seals are worn.	Shut off water to unit. Open valve by unscrewing valve bonnet. Inspect O-rings on valve stem and bonnet. Replace as required.
Hose is stiff and inflexible.	Plasticizers in PVC inner and outer core of hose may have leached out due to age, exposure to acids or alkalies, exposure to UV light, etc.	Replace hose immediately.
Hose shows signs of wear such as scrapes, cuts, fraying, tears or other abrasion.	Hose may have snagged or rubbed on sharp object or is wearing due to age.	Replace hose immediately.
Hose is not secure on end fittings. Hose turns freely on fittings or there is a gap or separation between the crimped ferrule and end fitting.	Hose may be working loose from fitting.	Replace hose immediately.

## Annual Compliance Inspection

As noted above, WaterSaver recommends, and ANSI Z358.1-2014 provides, that emergency equipment be inspected at least annually for continued compliance with the provisions of the standard. WaterSaver has prepared the following checklist to assist in the annual compliance inspection. This list is based upon the provisions of the ANSI standard relating to eyewash and drench hose units. Additional copies of the checklist may be requested from the factory or downloaded from our website.

## Eyewash/Drench Hose Unit

<b>Owner</b>		<b>Inspection Date</b>	
<b>Building</b>		<b>Inspected by</b>	
<b>Floor/Room No.</b>			

Item	ANSI Z358.1 Section Reference	Pass/ Fail	Corrective Action Required
<b>Location</b>			
1. Emergency eyewash/drench hose unit installed within 10 seconds walking time or 55 feet of hazard.	5.4.2/ Appendix B5		
2. Eyewash/drench hose unit is on same level as hazard and there is unobstructed travel path from hazard to unit.	5.4.2		
3. Unit identified with highly visible sign.	5.4.3/8.2.3.2		
4. Area around unit well lighted.	5.4.3/8.2.3.2		

<b>Installation</b>			
1. Unit connected to water supply delivering at least 0.4 GPM.	5.4.5		
2. Flushing fluid flow pattern positioned 33-53" from floor and at least 6" from wall or nearest obstruction.	5.4.4		
3. Valve actuator easy to locate and readily accessible to user.	5.2/8.2.2		
4. Spray heads protected from airborne contaminants.	5.1.3		

<b>Activation</b>			
1. Valve goes from "off" to "on" in one second or less.	5.2/8.2.2		
2. Once activated, valve stays open for "hands free" use.	5.2		
3. Water flow washes both eyes simultaneously and is controlled, low velocity and non-injurious to user.	5.1.1/8.2.1		
4. Unit delivers at least 0.4 GPM for 15 minutes.	5.1.6		
5. Water delivered by unit is tepid (60-100°F).	5.4.6/8.2.3.4		

<b>Training</b>			
1. All employees trained in location and proper use of eyewash/drench hose units.	5.5.4/8.2.4.4		



## Drench Hose Unit

<b>Owner</b>		<b>Inspection Date</b>	
<b>Building</b>		<b>Inspected by</b>	
<b>Floor/Room No.</b>			

Item	ANSI Z358.1 Section Reference	Pass/ Fail	Corrective Action Required
<b>Location</b>			
1. Verify emergency eyewash and shower equipment installed in vicinity of hazard.	8		
2. Unit identified with highly visible sign.	8.2.3.2		
3. Area around unit well lighted.	8.2.3.2		
4. Area around unit free of debris and obstructions.	8.2.3.2		

<b>Installation</b>			
1. Unit connected to water supply.	8.2.3.3		
2. Valve actuator easy to locate and readily accessible to user.	8.2.2		

<b>Activation</b>			
1. Valve goes from "off" to "on" in one second or less.	8.2.2		
2. Water flow is controlled, low velocity and non-injurious to user.	8.2.1		
3. Water delivered by unit is tepid (60-100°F).	8.2.3.4		

<b>Training</b>			
1. All employees trained in location and proper use of drench hose units.	8.2.4.4		

○ **AP600-240LC** Squeeze Valve with Locking Clip. 3/8" NPT Female Outlet.

*Note: Prior to 2002, WaterSaver manufactured the AP600-220-3 squeeze valve. This valve had an integral (non-removable) valve seat. In 2002, WaterSaver replaced this valve with the AP600-240 valve with a replaceable stainless steel valve seat. All eyewash/drench hose units and drench hose units manufactured after 2002 utilize the AP600-240 squeeze valve.*

**RK600-240**  
 Repair Kit for Squeeze Valve

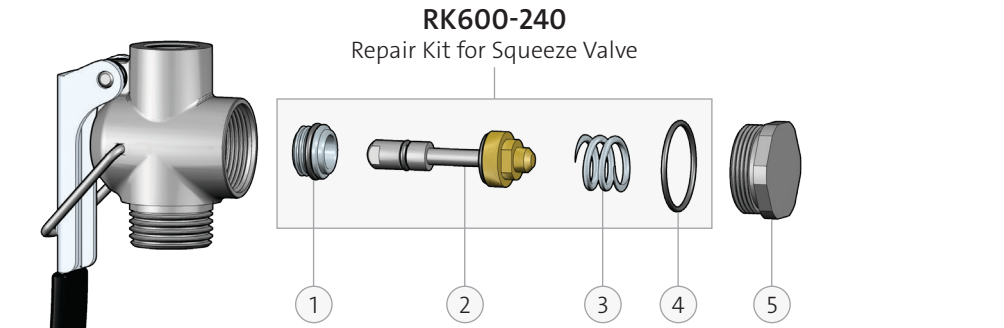

ITEM	PART NO.	DESCRIPTION
1	<b>AP600-249R</b>	Valve Seat and O-Ring Assy. (pkg of 6)
2	<b>AP600-241R</b>	Valve Plunger Assy. (pkg of 6)
3	<b>600-243A-R</b>	Spring (pkg of 6)
4	<b>600-244R</b>	Bonnet O-Ring (pkg of 6)
5	<b>600-245R</b>	Valve Bonnet (pkg of 6)

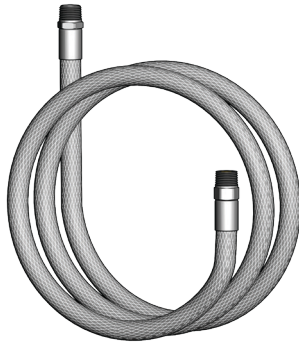

**AP350-100-096**  
 8 ft. reinforced PVC hose for eyewash/  
 drench hose and drench hose units.  
 3/8" NPT male swivel inlet,  
 3/8" NPT male outlet.



**350-007**  
 Molded nylon handle for  
 eyewash/drench hose and  
 drench hose units.



**AP350-011G**  
 Molded nylon deck flange for  
 eyewash/drench hose and drench  
 hose units. 1" IPS mounting shank.



**AP150-003A**  
 45 degree panel flange for eyewash/  
 drench hose and drench hose units.  
 3/4" IPS mounting shank.

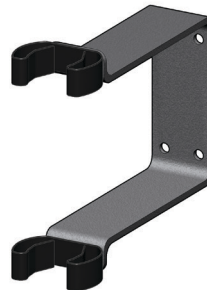

**AP150-051C**  
 Wall Bracket for  
 Eyewash/Drench Hose Units



**150-062A**  
 Wall Hook for  
 Drench Hose Units



**AP150-084**  
 Wall Bracket for  
 Eyewash/Drench Hose Units

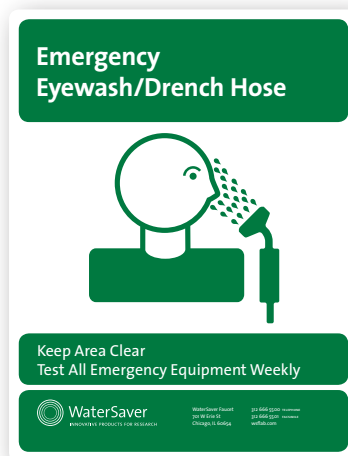

**250-010W**  
 8-1/2" x 11" plastic sign



**250-006W**  
 8-1/2" x 11" plastic sign

○ **GS-Plus™ Spray Head**

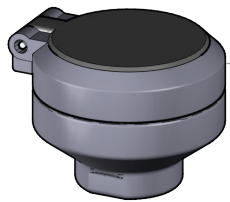

**AP470-001W**  
 GS-Plus™ Spray Head.  
 1-1/2" Diameter.  
 1/4" NPT female inlet.



**AP470-002W-R**  
 1-1/2" Diameter Spray  
 Cover with "Flip Top"  
 Dust Cover (pkg of 2)

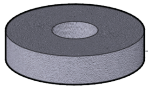

**470-004R**  
 1-1/8" Diameter Foam  
 Filter (pkg of 6)

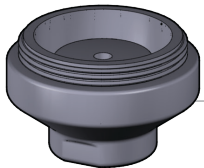

**470-001R**  
 GS-Plus™ Spray Head  
 Body (pkg of 6)



**470-005R**  
 1.6 Gallon Per Minute  
 Flow Control  
 (pkg of 6)

○ **FS-Plus™ Spray Head**

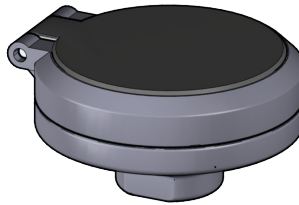

**AP470-021W**  
 FS-Plus™ Spray Head.  
 2-1/8" Diameter.  
 1/4" NPT female inlet.

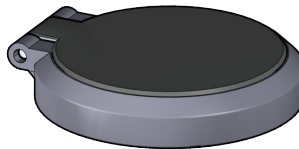

**AP470-022W-R**  
 2-1/8" Diameter Spray  
 Cover with "Flip Top"  
 Dust Cover (pkg of 2)

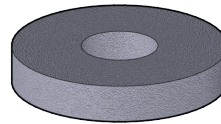

**470-024R**  
 1-3/4" Diameter Foam  
 Filter (pkg of 6)

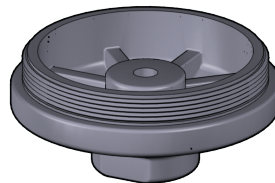

**470-021R**  
 FS-Plus™ Spray Head  
 Body (pkg of 6)



**470-025R**  
 3.2 Gallon Per Minute  
 Flow Control (pkg of 6)