

BT2860I-231WSA Push/Turn Gas Valve, Bench Mounted



Application: Flow control of burning or combustible gases such as natural gas, propane and bottled gas. Valve is certified for natural gas service by CSA International.

Mounting: Turret base for bench mounting with locator pins.

Valve Body: Straight pattern forged brass.

Headwork: Self-contained push/turn cartridge with rotating ceramic discs. Valve locks in closed position.

Handle: Forged brass handle with index disc and pop-up indicator buttons. Handle locks in closed position. Handle must be pushed down to unlock and open valve. Red pop-up buttons indicate if valve is open or closed. Handle and index disc are color coded and marked per EN 13792.

Inlet: Furnished with G1/2 mounting shank, locknut and washer. G1/2 male inlet.

Outlet: G3/8 female outlet. Furnished with removable straight serrated hose end or quick connect fitting with hose end, as ordered (see below).

Quality Assurance: Fitting is fully assembled and factory tested prior to shipment. 10 bar (150 PSI) test pressure and 7 bar (100 PSI) maximum working pressure.



Single Valve
BT2860I-231WSA

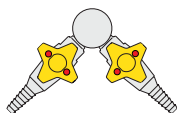

Two Valves at 90°
BT2860I-232AWSA

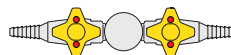

Two Valves at 180°
BT2860I-232SWSA

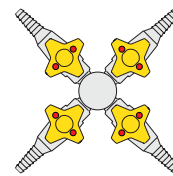

Four Valves
BT2860I-234WSA

Ordering Information

Valve Configurations

Outlet Fitting Options

Serrated hose end

BT2860I-231WSA

BT2860I-232AWSA

BT2860I-232SWSA

BT2860I-234WSA

Quick connect fitting with hose end

BT2863HI-231WSA

BT2863HI-232AWSA

BT2863HI-232SWSA

BT2863HI-234WSA

Note: If red pop-up indicator buttons are not required, delete suffix "I". Fitting will be furnished with molded nylon handle.

Product Finish

WHT Gloss white powder coated finish

PCL Polished chrome plated finish with clear epoxy coating

GRY Gloss light gray powder coated finish

SCC Satin chrome plated finish with clear epoxy coating

GRD Gloss dark gray powder coated finish

SNC Satin nickel plated finish with clear epoxy coating

STM Starburst metallic powder coated finish

Note: Refer to "Product Finishes" catalog for complete information on finishes.

Media

BT2860I-231WSA Push/Turn Gas Valve, Bench Mounted

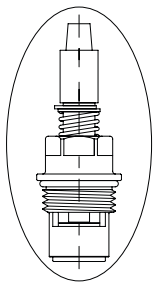
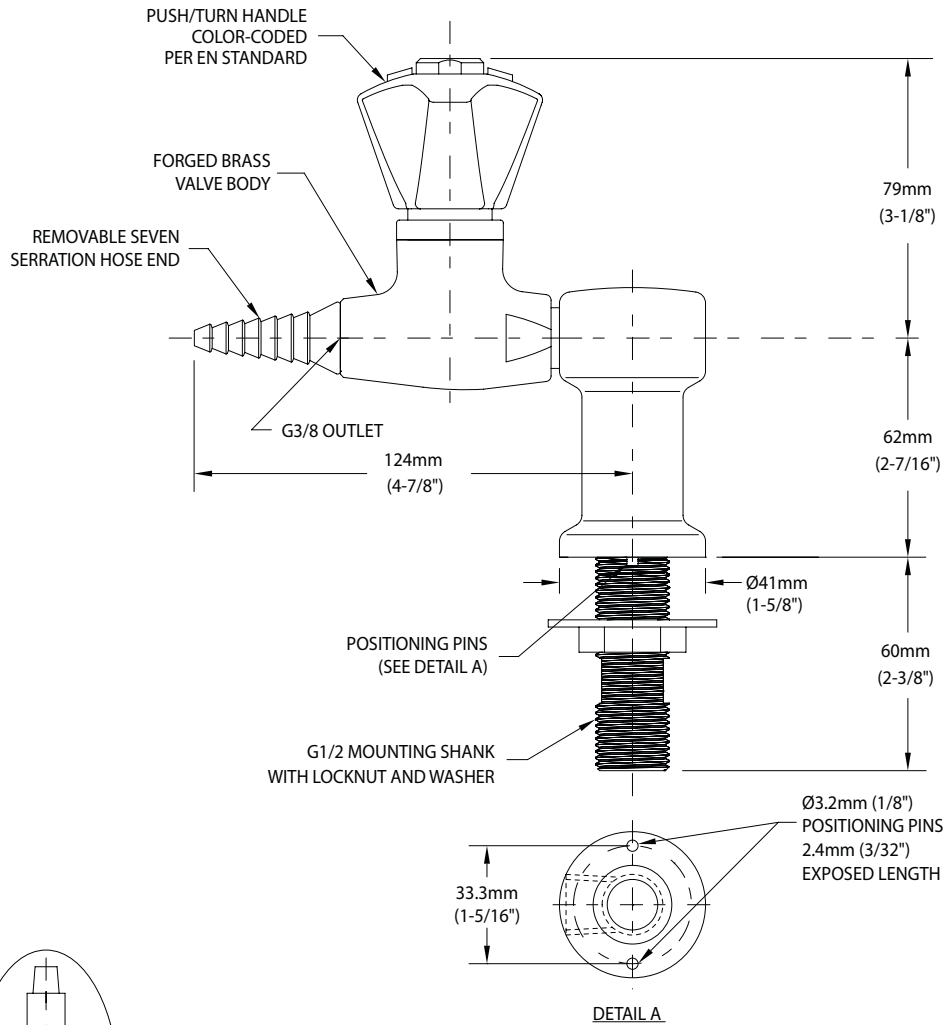

REPLACEABLE PUSH/TURN CERAMIC DISC CARTRIDGE



SINGLE VALVE:
 BT2860I-231WSA

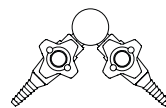

TWO VALVES AT 90°:
 BT2860I-232AWSA

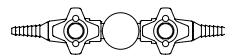

TWO VALVES AT 180°:
 BT2860I-232SWSA

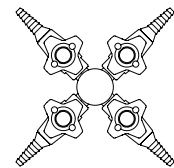

FOUR VALVES:
 BT2860I-234WSA

NOTES:

1. FITTING IS FACTORY ASSEMBLED AND TESTED AT 10 BAR (150 PSI). MAXIMUM WORKING PRESSURE IS 7 BAR (100 PSI).

Rev.050318

THIS SPACE FOR ARCHITECT/ENGINEER APPROVAL

Due to continuing product improvement, the information contained in this document is subject to change without notice. All dimensions are ± 6mm (1/4"). Rev. 050318